

## Basic Operating Instructions

---

### 4K Video Camera

Model No.

# HC-VX3

### High Definition Video Camera

Model No.

# HC-V900

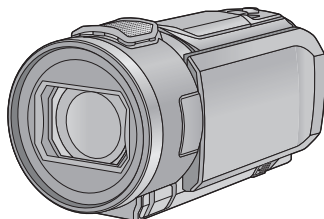

Please read these instructions carefully before using this product, and save this manual for future use.

More detailed operating instructions are available in "Operating Instructions (PDF format)". To read it, download it from the website.

<https://panasonic.jp/support/video/oi/VX3/index.html>

- Click the desired language.



Web Site: <http://www.panasonic.com>

DVQX2556ZA

F0924MZ0

# Information for Your Safety

## Dear Customer,

We would like to take this opportunity to thank you for purchasing this Panasonic Video Camera. Please read these Operating Instructions carefully and keep them handy for future reference. Please note that the actual controls and components, menu items, etc. of your Video Camera may look somewhat different from those shown in the illustrations in these Operating Instructions.

### WARNING:

To reduce the risk of fire, electric shock or product damage,

- Do not expose this unit to rain, moisture, dripping or splashing.
- Do not place objects filled with liquids, such as vases, on this unit.
- Use the recommended accessories.
- Do not remove covers.
- Do not repair this unit by yourself. Refer servicing to qualified service personnel.

This unit is intended for use in moderate climates.

## ■ Concerning the battery

### Warning

Risk of fire, explosion and burns. Do not disassemble, heat above 60 °C or incinerate.



### CAUTION

- Danger of explosion if battery is incorrectly replaced. Replace only with the type recommended by the manufacturer.
- When disposing of the batteries, please contact your local authorities or dealer and ask for the correct method of disposal.

## ■ EMC Electric and magnetic compatibility

This symbol (CE) is located on the rating plate.

## ■ Product identification marking

Product	Location
 4K Video Camera	Battery holder
 High Definition Video Camera	Battery holder

## ■ Disposal of Old Equipment and Batteries

### Only for European Union and countries with recycling systems



These symbols on the products, packaging, and/or accompanying documents mean that used electrical and electronic products and batteries must not be mixed with general household waste. For proper treatment, recovery and recycling of old products and used batteries, please take them to applicable collection points in accordance with your national legislation. By disposing of them correctly, you will help to save valuable resources and prevent any potential negative effects on human health and the environment. For more information about collection and recycling, please contact your local authority. Penalties may be applicable for incorrect disposal of this waste, in accordance with national legislation.



#### **Note for the battery symbol (bottom symbol):**

This symbol might be used in combination with a chemical symbol. In this case it complies with the requirement set by the Directive for the chemical involved.

### **For Turkey**

AEEE Yönetmeliğine Uygundur.

AEEE Complies with Directive of Turkey.

## ■ Cautions for use

- The power consumption of this unit may increase if [ECONOMY (BATT)]/[ECONOMY (AC)] is set to [OFF].
- For more information about the energy efficiency of the product, please visit our website, [www.panasonic.com](http://www.panasonic.com), and enter the model number in the search box.

**The unit and the SD card become warm during use. This is not a malfunction.**

### **Keep this unit as far away as possible from electromagnetic equipment (such as microwave ovens, TVs, video games etc.).**

- If you use this unit on top of or near a TV, the pictures and/or sound on this unit may be disrupted by electromagnetic wave radiation.
- Do not use this unit near cell phones because doing so may result in noise adversely affecting the pictures and/or sound.
- Recorded data may be damaged, or pictures may be distorted, by strong magnetic fields created by speakers or large motors.
- Electromagnetic wave radiation generated by microprocessors may adversely affect this unit, disturbing the pictures and/or sound.
- If this unit is adversely affected by electromagnetic equipment and stops functioning properly, turn this unit off and remove the battery or disconnect AC adaptor. Then reinsert the battery or reconnect AC adaptor and turn this unit on.

### **Do not use this unit near radio transmitters or high-voltage lines.**

- If you record near radio transmitters or high-voltage lines, the recorded pictures and/or sound may be adversely affected.

### **About connecting to a PC**

- Do not use any other USB cables except the supplied one.

### **About connecting to a TV**

- Do not use any other HDMI micro cables except the supplied one.

### **About using a headphone**

- Excessive sound pressure from earphones and headphones can cause hearing loss.

### **Do not extend the cords and the cables.**

### **Do not spray insecticides or volatile chemicals onto the unit.**

- If the unit is sprayed with such chemicals, its body may be marred and the surface finish may peel off.

### **Do not leave rubber or plastic products in contact with the unit for a long time.**

### **Cleaning**

- Before cleaning, detach the battery or pull the AC adaptor from the AC outlet, and then wipe the unit with a soft, dry cloth.
- If the unit is very dirty, dip a cloth in water and squeeze firmly, and then wipe the unit with the damp cloth. Next, dry the unit with a dry cloth.
- Use of benzine, paint thinner, alcohol, or dishwashing liquid may alter the camera body or peel the surface finish. Do not use these solvents.
- When using a chemical dust cloth, follow the instructions that came with the cloth.

### **When you are not going to use the unit for an extended time**

- When storing the unit in a cupboard or cabinet, it is recommended that you place a desiccant (silica gel) in with it.

### Be sure to detach the battery after use.

- If the battery is left attached, a minute amount of current continues to flow even if the unit is off. Keeping the unit in this state may result in over discharge of the battery. This may result in you not being able to use the battery even after it is charged.
- The battery should be stored in a cool place free from humidity, with as constant temperature as possible. (Recommended temperature: 15 °C to 25 °C, Recommended humidity: 40%RH to 60%RH)
- To store the battery for a long period of time, we recommend you charge it once every year and store it again after you have completely used up the charged capacity.

If the operating time is very short even after the battery has been recharged, the battery has worn out. Please purchase a new battery.

### About the SD card

- When the card access lamp is lit, do not:
  - Remove the SD card
  - Turn the unit off
  - Insert and remove the USB cable
  - Expose the unit to vibrations or shock

### About the accessory shoe cover

- Close accessory shoe cover **A** when not using the accessory shoe.
- For details about accessory shoe cover, refer to the Operating Instructions (PDF format).

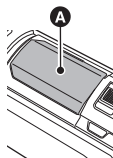

## ■ About the recording format for recording motion pictures

- Motion pictures recorded with other devices are not supported by this unit.

For the **VX3**, you can select from AVCHD, 4K MP4, MP4 or 24p recording formats to record motion pictures.

For the **V900**, you can select from AVCHD, MP4 or 24p recording formats to record motion pictures.

- Motion pictures recorded with AVCHD and motion pictures recorded with 4K MP4/MP4/24p are not compatible with each other.

### AVCHD:

It is suitable for viewing on a high-definition TV or for saving to disc.

- It is compatible with the AVCHD Progressive (1080/50p).
- Images recorded in 1080/50p can be saved using the following methods:
  - Copying to a disc using the HD Writer AE 5.4.
  - Copying to a Panasonic Blu-ray disc recorder that supports AVCHD Progressive.

### 4K MP4:

This is a recording format suitable for editing images.



- This format can record 4K motion pictures (3840×2160/25p), which deliver a resolution four times higher than that of full high-definition motion pictures.

### MP4:

This is a recording format suitable for playing back or editing on a PC.

## 24p:

This allows you to record images similar to those shot on a roll of cinema film.

- Recording with the following picture qualities is possible:
  - For the  4K motion pictures (3840×2160/24p) or high-definition picture quality (1920×1080/24p)
  - For the  High-definition picture quality (1920×1080/24p)
- This unit restarts when you change the [REC FORMAT] setting to [24p] or change it from [24p] to a different setting.

## ■ Indemnity about recorded content

Panasonic does not accept any responsibility for damages directly or indirectly due to any type of problems that result in loss of recording or edited content, and does not guarantee any content if recording or editing does not work properly. Likewise, the above also applies in a case where any type of repair is made to the unit.

## ■ About Condensation

### (When the lens or LCD Monitor is fogged up)

Condensation occurs when there is a change in temperature or humidity, such as when the unit is taken from outside or a cold room to a warm room. Please be careful, as it may cause the lens or LCD monitor to become soiled, moldy, or damaged.

When taking the unit to a place which has a different temperature, if the unit is accustomed to the room temperature of the destination for about one hour, condensation can be prevented. (When the difference in temperature is severe, place the unit in a plastic bag or the like, remove air from the bag, and seal the bag.)

When condensation has occurred, remove the battery and/or the AC adapter and leave the unit like that for about one hour. When the unit becomes accustomed to the surrounding temperature, fogging will disappear naturally.

## ■ Cards that you can use with this unit





### SD Memory Card, SDHC Memory Card and SDXC Memory Card

- 4 GB or more Memory Cards that do not have the SDHC logo or 48 GB or more Memory Cards that do not have the SDXC logo are not based on SD Memory Card Specifications.
- Refer to page 15 for more details on SD cards.



## ■ Caution regarding the lens



Do not aim the lens at the sun or strong light. Doing so may cause the unit to malfunction.

## ■ For the purposes of these operating instructions

- SD Memory Card, SDHC Memory Card and SDXC Memory Card are referred to as the “SD card”.
- Function that can be used for Motion Picture Recording Mode: 
- Function that can be used for Still Picture Recording Mode: 
- Function that can be used for the Playback Mode: 
  - Function that can be used for the Playback Mode (motion pictures only): 
  - Function that can be used for the Playback Mode (still pictures only): 
- Scene(s) recorded in the recording format [AVCHD]: “AVCHD scene(s)”

- Scene(s) recorded in the recording format [4K MP4] and scene(s) recorded in 4K Photo mode: "4K MP4 scene(s)"
- Scene(s) recorded in the recording format [MP4], scene(s) saved in MP4 (1920×1080/25p), MP4 (1280×720/25p) or MP4 (640×360/25p): "MP4 scene(s)"
- Scene(s) recorded in the recording format [24p]: "24p scene(s)"
- Pages for reference are indicated by an arrow, for example: → 00
- Model numbers are abbreviated as follows in these operating instructions:

Model number	Abbreviation used in these operating instructions	
HC-VX3		[VX3]
HC-V900		[V900]

These operating instructions are designed for use with models  and . Pictures may be slightly different from the original.

- The illustrations used in these operating instructions show model , however, parts of the explanation refer to different models.
- Images and illustrations used in this document are for explaining the functions.
- Depending on the model, some functions are not available.
- Features may vary, so please read carefully.
- Not all models may be available depending on the region of purchase.



## ■ Installing HD Writer AE 5.4

Check the website below to download/install the software.

- The software is available for download until the end of November 2029.  
[https://panasonic.jp/support/global/cs/soft/download/f\\_ae54.html](https://panasonic.jp/support/global/cs/soft/download/f_ae54.html)

## ■ Downloading the Operating Instructions (PDF format)

You can check the URL and QR code of the website where you can download the Operating Instructions (PDF format) in [ONLINE MANUAL] in the Setup menu.

- Touch ◀ (left side)/ ▶ (right side) of  on the Touch Menu to display  . (→ 21)
- 1 Touch  .
  - 2 Touch [SETUP].
  - 3 Touch [ONLINE MANUAL].
  - 4 Touch the access method you want to check.

### [URL display]:

Displays the URL of the website on the LCD monitor of this unit.

### [USB connect]:

Displays the website on a PC connected to this unit with the USB cable. Click [OIBOOK], which will be displayed on the PC.

### [QR code]:

Displays the QR code of the website on the LCD monitor of this unit.

- You will need Adobe Reader to browse or print the Operating Instructions (PDF format).  
You can download and install a version of Adobe Reader that you can use with your OS from the following website. (As of September 2024)  
<http://www.adobe.com/products/acrobat/readstep2.html>

# Contents

Information for Your Safety .....	2
Accessories .....	10

---

## Preparation

---

<b>Power supply</b> .....	11
Inserting/removing the battery.....	11
Charging the battery .....	12
Charging and recording time.....	14
<b>Recording to a card</b> .....	15
Cards that you can use with this unit .....	15
Inserting/removing an SD card.....	16
<b>Turning the unit on/off</b> .....	17
<b>Selecting a mode</b> .....	18
Switching this unit between Recording Mode and Playback Mode .....	18
Switching this unit between Motion Picture Recording Mode and Still Picture Recording Mode.....	19
<b>LCD monitor</b> .....	20
How to use the touch screen .....	20
About the Touch Menu.....	21
<b>Setting date and time</b> .....	21
<b>Setting your home region for the first time</b> .....	22

---

## Basic

---

<b>Changing the Recording Mode</b> .....	22
<b>Recording motion pictures</b> .....	24
<b>Recording still pictures</b> .....	24
<b>Motion picture/Still picture playback</b> ...	25
Watching Video/Pictures on your TV ...	26
<b>Using the menu screen</b> .....	27
Language selection .....	27
Formatting .....	27

---

## Others

---

<b>Troubleshooting</b> .....	28
<b>Specifications</b> .....	30
<b>About copyright</b> .....	34

## For United Kingdom and Ireland customers

### ■ Sales and Support Information

#### Customer Communications Centre

- For customers within the UK: 0344 844 3899
- For customers within Ireland: 01 289 8333
- Monday–Friday 9:00 am – 5:00 pm  
(Excluding public holidays).
- For further support on your product, please visit our website:  
[www.panasonic.co.uk](http://www.panasonic.co.uk)

#### Direct Sales at Panasonic UK

- Order accessory and consumable items for your product with ease and confidence by phoning our Customer Communications Centre  
Monday–Friday 9:00 am – 5:00 pm  
(Excluding public holidays).
- Or go on line through our Internet Accessory ordering application at [www.pas-europe.com](http://www.pas-europe.com).
- Most major credit and debit cards accepted.
- All enquiries transactions and distribution facilities are provided directly by Panasonic UK.
- It couldn't be simpler!
- Also available through our Internet is direct shopping for a wide range of finished products. Take a browse on our website for further details.

# Accessories

Check the accessories before using this unit.

Keep the accessories out of reach of children to prevent swallowing.

Product numbers correct as of September 2024. These may be subject to change.

## Battery pack

VW-VBT190



## USB cable

K1HY24YY0030



## HDMI micro cable

K1HY19YY0038



## Lens hood

1ZE1VX3KZ

- For details on how to attach the lens hood, refer to the Operating Instructions (PDF format).



## Optional accessories

Some optional accessories may not be available in some countries.

Battery pack (lithium/VW-VBT190)
Battery pack (lithium/VW-VBT380)
AC adaptor (DMW-AC11)*
Stereo microphone (VW-VMS10E)

\* Includes power cord and USB cable.

# Power supply

## ■ About batteries that you can use with this unit

The battery that can be used with this unit is VW-VBT190/VW-VBT380.

- The unit has a function for distinguishing batteries which can be used safely. The dedicated battery (VW-VBT190/VW-VBT380) supports this function. The only batteries suitable for use with this unit are genuine Panasonic products and batteries manufactured by other companies and certified by Panasonic. Panasonic cannot in any way guarantee the quality, performance or safety of batteries which have been manufactured by other companies and are not genuine Panasonic products.

It has been found that counterfeit battery packs which look very similar to the genuine product are made available to purchase in some markets. Some of these battery packs are not adequately protected with internal protection to meet the requirements of appropriate safety standards. There is a possibility that these battery packs may lead to fire or explosion. Please be advised that we are not liable for any accident or failure occurring as a result of use of a counterfeit battery pack. To ensure that safe products are used we would recommend that a genuine Panasonic battery pack is used.

## Inserting/removing the battery

- Press the power button to turn off the unit. (→ 17)

Install the battery by inserting it in the direction shown in the figure.

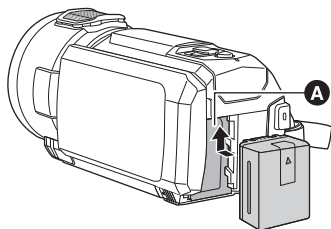

**A** Battery holder

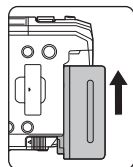

While holding the battery against the battery holder, push the battery upwards until you hear it click into place.

### Removing the battery

Be sure to hold down the power button until the status indicator goes off. Then remove the battery while supporting the unit to prevent it from dropping.

**Move the battery release lever in the direction indicated by the arrow and remove the battery when unlocked.**

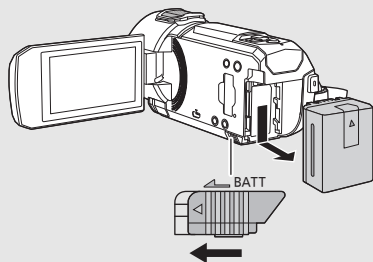

# Charging the battery

Charge using an AC adaptor (optional/commercially available) and a USB cable (supplied/commercially available).

**When this unit is purchased, the battery is not charged. Charge the battery fully before using this unit for the first time.**

## Important:

- Do not use the USB cable with any other equipment as it is designed only for this unit.
- The battery will not be charged if the unit is turned on.
- It is recommended to charge the battery in a temperature between 10 °C and 30 °C. (The battery temperature should also be the same.)

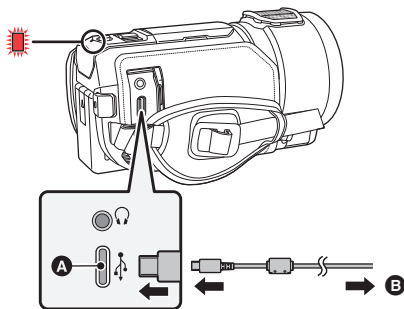

- A** USB terminal
- B** To the AC adaptor

## 1 Connect the USB cable to the AC adaptor and to the USB terminal of this unit.

- Insert the plugs as far as they will go.

## 2 Insert the AC adaptor into an AC outlet.

- The status indicator will flash red at an interval of approximately 2 seconds (approximately 1 second on, approximately 1 second off), indicating that charging has begun. It will turn off when the charging is completed. (→ 17)

## ■ Connecting to the AC outlet

It is possible to use this unit with power supplied from the AC outlet by turning on the unit with the AC adaptor connected.

Even when you use the AC adaptor for recording images, keep the battery connected.

This allows you to continue the recording even if a power failure occurs or the AC adaptor is unplugged from the AC outlet by accident.

## ■ To charge by connecting to other device

It is possible to charge by connecting to other device with the USB cable (supplied).

- We recommend using an optional Panasonic AC adaptor (DMW-AC11) to supply power and charge.
- A commercially available AC adaptor and USB cable can be used to supply power and charge this unit.
  - \*Recommended specifications for the commercially available AC adaptor
    - Supports 5 V/3 A (15 W) DC output
    - USB Type-C terminal
  - \*For supplying power and charging, use either the supplied USB cable or a USB cable with an output rating of 15 W or greater.
- You can also use an AC adaptor with 5 V/1.5 A or better for charging.  
However, charging time may be longer than with the recommended AC adaptor.
- Operation is not guaranteed with all commercially available devices.
- We recommend using Panasonic batteries (→ 11).
- If you use other batteries, we cannot guarantee the quality of this product.
- Do not heat or expose to flame.
- Do not leave the battery(ies) in a car exposed to direct sunlight for a long period of time with doors and windows closed.
- Do not expose to low air pressure at high altitudes.
- Do not expose to extremely low air pressure, as this may result in explosions or leakage of flammable liquids and gases.



The power delivered by the charger must be between min. 2.5 Watts required by this product, and max. 15 Watts in order to achieve the maximum charging speed.

# Charging and recording time

## ■ Charging/Recording time

- Temperature: 25 °C/humidity: 60%RH
- When using the LCD monitor
- **Charging times are measured under the following conditions:**
  - Using this unit and an AC adaptor (DMW-AC11: optional)
  - Charged after battery is fully depleted
- Charging time and recordable time vary depending on the usage conditions such as high/low temperature.

Battery model number [Voltage/Capacity (minimum)]	Charging time	Recording format	Recording mode	Maximum continuous recordable time	Actual recordable time
Supplied battery/ VW-VBT190 (optional) [3.6 V/1940 mAh]	2 h 20 min	[4K MP4]*	[2160]	1 h 35 min	50 min
		[MP4]	[1080/50M]	1 h 50 min	55 min
			[1080/28M]		
			[720]	2 h 15 min	1 h 10 min
		[AVCHD]	[1080/50p]	1 h 50 min	55 min
			[PH], [HA], [HG], [HE]	1 h 55 min	1 h
			[24p]	[2160/24p]*	1 h 40 min
		[1080/24p]		1 h 50 min	55 min
VW-VBT380 (optional) [3.6 V/3880 mAh]	3 h 45 min	[4K MP4]*	[2160]	3 h 30 min	1 h 45 min
		[MP4]	[1080/50M]	3 h 55 min	2 h
			[1080/28M]		
			[720]	4 h 45 min	2 h 25 min
		[AVCHD]	[1080/50p]	3 h 55 min	2 h
			[PH]	4 h	2 h 5 min
			[HA], [HG], [HE]	4 h 5 min	
		[24p]	[2160/24p]*	3 h 35 min	1 h 50 min
[1080/24p]	4 h		2 h 5 min		



\* For the VX3

- "h" is an abbreviation for hour, "min" for minute and "s" for second.
- These times are approximations.
- The actual recordable time refers to the recordable time when repeatedly starting/stopping recording, turning the unit on/off, moving the zoom lever etc.

## ■ Battery capacity indication

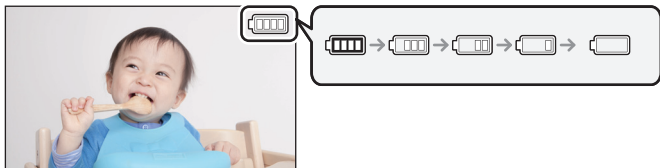
The battery capacity indication is displayed on the LCD monitor.



- If there is less than 3 minutes remaining, then  will become red. If the battery discharges, then  will flash. Recharge the battery or replace it with a fully charged battery.

Preparation

## Recording to a card

The unit can record still pictures or motion pictures to an SD card.

### Cards that you can use with this unit

#### SD memory card/SDHC memory card/SDXC memory card (Maximum 512 GB)

- Please check the latest information on the support website below.  
[https://panasonic.jp/support/global/cs/e\\_cam/index.html](https://panasonic.jp/support/global/cs/e_cam/index.html)  
(This website is in English only.)
- We do not guarantee the operation of SD cards other than the ones above.
- Operation is not guaranteed for all SD cards.
- Keep the memory card out of reach of children to prevent swallowing.

## ■ About the Speed Class ratings for recording motion pictures

Depending on [REC MODE] and [REC FORMAT], the required card differs.

Use a card that meets the following ratings of the SD Speed Class. Use of a non-compatible card may cause recording to stop suddenly.

- SD Speed Class is the speed standards regarding continuous writing. To check the class, see the labelled side, etc. of the card.

Recording formats	Recording modes	Speed Class ratings	Label examples
4K MP4*	[2160]	Class 10	CLASS 10
24p	[2160/24p]*, [1080/24p]		
MP4	[1080/50M]	Class 4 or more	CLASS 4
	[1080/28M], [720]		
AVCHD	All		

\* For the 

- In the following situations, you need an SD card conforming to Class 10 of the SD Speed Class Rating to record motion pictures.

Use of a non-compatible card may cause recording to stop suddenly.

- FULL HD Slow Motion Video Mode

(For the **VX3**)

- 4K Photo Mode
- Slow & Quick Video Mode

## Inserting/removing an SD card

Before using SD cards to be used on this unit, format with this unit. (→ 27) When the SD card is formatted, all of the recorded data is deleted. Once the data is deleted, it cannot be restored.

**Caution:**

**Check that the access lamp has gone off.**

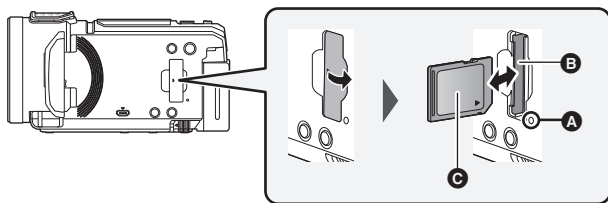

### Access lamp [ACCESS] **A**

- When this unit is accessing the SD card, the access lamp lights up.

### **1** Open the SD card cover and insert (remove) the SD card into (from) the card slot **B**.

- Face the label side **C** in the direction shown in the illustration and press it straight in as far as it will go.
- Press the centre of the SD card and then pull it straight out.

### **2** Securely close the SD card cover.

- Securely close it until it clicks.

## Turning the unit on/off

You can turn the unit on and off using the power button or by opening and closing the LCD monitor.

### Turning the unit on and off with the power button

Open the LCD monitor and press the power button to turn on the unit.

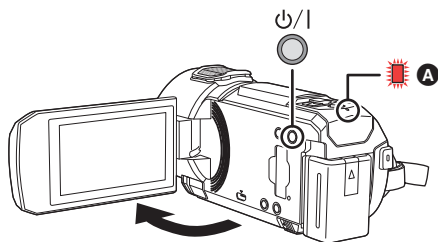

#### To turn off the unit

Hold down the power button until the status indicator goes off.

**A** The status indicator lights on.

The unit is turned on when the LCD monitor is opened, and unit is turned off when it is closed.

#### ■ Overheat detection

When the internal temperature of the unit rises during use, a message will be displayed. When this happens, the unit will turn off automatically a few minutes later.

- Wait until the temperature has dropped before resuming use.

## Selecting a mode

You can switch this unit between Recording Mode (Motion Picture Recording Mode/Still Picture Recording Mode) and Playback Mode by pressing the recording/playback button.

If you touch the recording mode switching icon in Recording Mode, this unit can be switched between Motion Picture Recording Mode and Still Picture Recording Mode.

<b>Motion Picture Recording Mode (→ 24)</b>	<b>Recording motion pictures.</b>
<b>Still Picture Recording Mode (→ 24)</b>	<b>Recording still pictures.</b>
<b>Playback Mode (→ 25)</b>	<b>Motion picture/Still picture playback.</b>

## Switching this unit between Recording Mode and Playback Mode

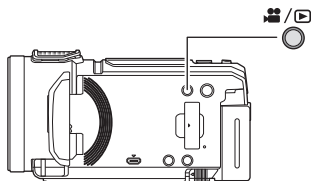

### Recording/playback button

Press the button to switch this unit between Recording Mode and Playback Mode.



- When you turn on this unit, it starts up in Recording Mode.

# Switching this unit between Motion Picture Recording Mode and Still Picture Recording Mode

Touch the recording mode switching icon displayed on the LCD monitor (touch screen) to switch this unit between Motion Picture Recording Mode and Still Picture Recording Mode.

## 1 Press the recording/playback button to switch this unit to Recording Mode.

- The recording mode switching icon **A** is displayed on the screen.

	Motion Picture Recording Mode
	Still Picture Recording Mode

(Motion Picture Recording Mode)



## 2 Touch the recording mode switching icon.

- Refer to page 20 for touch screen operation.

### ***To display the recording mode switching icon***

Display of the recording mode switching icon will disappear when no touch operation is performed for a specific period of time. To display it again, touch the screen.

- If the recording start/stop button is pressed in Still Picture Recording Mode or Playback Mode, this unit will be switched to Motion Picture Recording Mode. During motion picture/still picture playback or in other conditions, even if the recording start/stop button is pressed, the recording mode may not be switched.
- When you switch between Motion Picture Recording Mode and Still Picture Recording Mode, settings used in the original recording mode may not be maintained. (→ 22)
- You cannot switch to Still Picture Recording Mode when [REC FORMAT] is set to [24p].

# LCD monitor

## How to use the touch screen

You can operate by directly touching the LCD monitor (touch screen) with your finger.

### ■ Touch

Touch and release the touch screen to select icon or picture.

- Touch the centre of the icon.
- Touching the touch screen will not operate while you are touching another part of the touch screen.

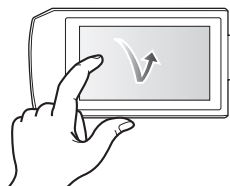

### ■ Slide while touching

Move your finger while pressing on the touch screen.

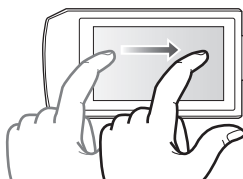

### ■ About the operation icons



Touch when changing a page or performing settings.



Touch to return to the previous screen.



## About the Touch Menu

Touch ◀ (left side)/▶ (right side) of  on the Touch Menu to switch the operation icons.

- It is also possible to switch the operation icons by sliding the Touch Menu right or left while touching it.

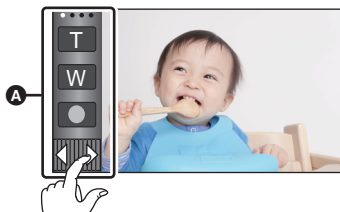

A Touch Menu

### ■ To display the Touch Menu



Display of the Touch Menu will disappear when no touch operation is performed for a specific period of time during recording of motion picture/still picture. To display it again, touch .

Preparation

## Setting date and time

The clock is not set at the time of purchase. Make sure to set the clock.

- When you turn on this unit, the message “Set home region and date/time.” may be displayed. Select [YES], and follow the steps below to make these settings:
  - Step 2 of “Setting your home region for the first time”
  - Steps 2–3 of “Setting date and time”

### 1 Select the menu. (→ 27)

MENU : [SETUP] → [CLOCK SET]

### 2 Touch the date or time to be set, then set the desired value using / .

#### A Displaying the World Time setting:

 [HOME]/  [DESTINATION]

- The year can be set between 2000 and 2039.

### 3 Touch [ENTER].

- Touch [EXIT] to complete the setting.



# Setting your home region for the first time

You can set your home region in [SET WORLD TIME].

## 1 Select the menu. (→ 27)

[MENU] : [SETUP] → [SET WORLD TIME]

- A message will be displayed. Touch [ENTER].

## 2 Touch ◀/▶ to select your home region and touch [ENTER].

- When the clock is not set, the current time is displayed as "--:--".



- A The current time
- B The time difference from GMT (Greenwich Mean Time)

- For information on how to change your home region or set the region of your travel destination, refer to the Operating Instructions (PDF format).



# Changing the Recording Mode

## 1 Touch the Recording Mode button icon.







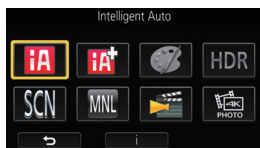



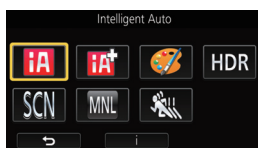

## 2 Touch the desired Recording Mode button icon.

VX3



V900



Mode		Effect
 *1  *2	<b>Intelligent Auto</b>	You can switch the mode to the Intelligent Auto Mode, which optimises settings to the recording environment you are in.
 *1  *2	<b>Intelligent Auto Plus</b>	You can add manually-adjusted brightness and colour balance settings to the Intelligent Auto Mode, and record.
 *1	<b>Creative Control</b>	You can record motion pictures with added effects.
<b>HDR</b> *1	<b>HDR Movie</b>	You can minimise the loss of gradations in bright areas and dark areas when, for example, the contrast between the background and the subject is large.
<b>SCN</b>	<b>Scene Mode</b>	This option allows this unit to automatically adjust the shutter speed and aperture, etc. according to the scene you want to record.
	<b>Manual</b>	You can set the shutter speed, focus, White Balance, and brightness (iris/gain).
 *1, 3	<b>Cinema Like Effect</b>	You can record images with cinematic effects.
 *1, 4	<b>FULL HD Slow Motion Video</b>	You can record slow motion pictures.
 *1, 3	<b>4K Photo</b>	You can record motion pictures optimised for capturing still pictures from 4K motion pictures.
 *2	<b>Stop Motion Animation Assist</b>	You can set a recorded still picture as the background, and record the next picture while looking at that recorded picture as the background.

\*1 In Motion Picture Recording Mode only

\*2 In Still Picture Recording Mode only

\*3 For the 

\*4 For the 



## Recording motion pictures

- 1 Open the LCD monitor to switch to Motion Picture Recording Mode. (→ 19)
- 2 Press the recording start/stop button to start recording.

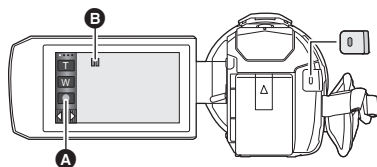

- A Recording button icon
- B When you begin recording, changes to .

- 3 Press the recording start/stop button again to pause recording.
  - Recording can also be started/stopped by touching the recording button icon.



## Recording still pictures

- 1 Open the LCD monitor to switch to Still Picture Recording Mode. (→ 19)
- 2 Press the button halfway. (For Auto Focus only)



- 3 Press the button fully.

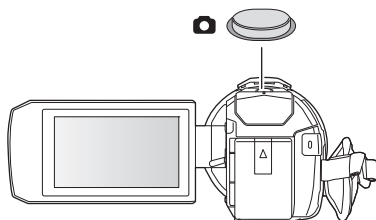

# Motion picture/Still picture playback



(Screens are examples from when motion pictures are recorded)

- 1 Set this unit to Playback Mode. (→ 18)
- 2 Touch the motion picture/still picture tab **A**.

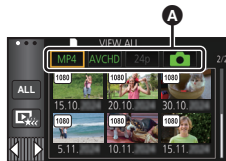

**[MP4]:** 4K MP4\* and MP4 scenes are displayed as thumbnails.

**[AVCHD]:** AVCHD scenes are displayed as thumbnails.

**[24p]:** 2160/24p\* and 1080/24p scenes are displayed as thumbnails.

**[📷]:** Still pictures are displayed as thumbnails.

\* For the

- If there are recorded scenes/still pictures, the letters and icons on the motion picture/still picture tabs are displayed in green.
- The following icons are displayed on thumbnails when [MP4] is touched:
  - MP4 [2160/25p] scene:  (For the )
  - MP4 [1080/50p] scene:  (Blue) (Recording mode [1080/50M])  
 (Recording mode [1080/28M])
  - MP4 [1080/25p] scene:
  - MP4 [720/25p] scene:
  - MP4 [360/25p] scene:
- The following icons are displayed on thumbnails when [AVCHD] is touched:
  - AVCHD [1080/50p] scene:
  - AVCHD [PH] scene:
  - AVCHD [HA] scene:
  - AVCHD [HG] scene:
  - AVCHD [HE] scene:
- The following icons are displayed on thumbnails when [24p] is touched:
  - MP4 [2160/24p] scene:  (For the )
  - MP4 [1080/24p] scene:

### 3 Touch the scene or the still picture to be played back.

- To display the next (previous) page:
  - Slide the thumbnail display upward (downward) while touching it.
  - Switch the Touch Menu, and then touch ▲ (up) / ▼ (down) on the thumbnail scroll lever.



### 4 Select the playback operation by touching the operation icon.

- Operation icons and screen display will disappear when no touch operation is performed for a specific period of time. To display them again, touch the screen.
- Touch ►/⏸ to start/pause playback of motion pictures.



Operation icon

- The unit will restart if you switch to a different motion picture/still picture tab as below.
  - Switching from [24p]<sup>\*1</sup> to [MP4] or [AVCHD]
  - Switching from [MP4] or [AVCHD] to [24p]<sup>\*2</sup>

\*1 Including when you switched from [24p] to 📷 (still picture) first.

\*2 Including when you switched from [MP4] or [AVCHD] to 📷 (still picture) first.

## Watching Video/Pictures on your TV



Connect this unit to a TV using an HDMI micro cable (supplied).

- Ⓐ HDMI micro connector [HDMI]
- Be sure to connect to the HDMI terminal. (Insert the connector with the arrow side facing up.)

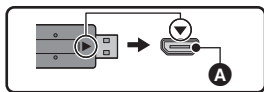

# Using the menu screen

- Touch ◀ (left side)/ ▶ (right side) of  on the Touch Menu to display . (→ 21)

## 1 Touch .



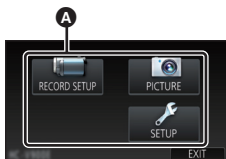

## 2 Touch the top menu .

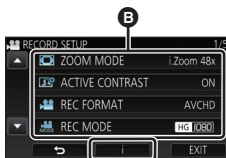

## 3 Touch the submenu .



- Next (previous) page is displayed by touching  / .

## 4 Touch the desired item to enter the setting.

## 5 Touch [EXIT] to exit the menu setting.

### ■ About guide display

After touching , touching the submenus and items will cause function descriptions and settings confirmation messages to appear.

- After the messages have been displayed, the guide display is cancelled.

### ■ About the MENU button

Press the MENU button to display the menu screen (top menu).

Press again to exit the menu screen.

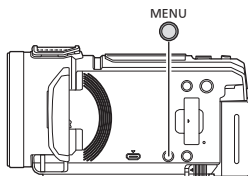

## Language selection

You can select the language on the screen display and the menu screen.

 : [SETUP] → [LANGUAGE] →  
desired language

## Formatting

Please be aware that if a medium is formatted, then all the data recorded on the medium will be erased and cannot be restored. Back up important data on a PC, DVD disc etc.

 : [SETUP] → [FORMAT MEDIA]

- Do not format an SD card using any other equipment such as a PC. The card may not be used on this unit.

# Troubleshooting

## ■ It is not a malfunction in following cases

<p><b>A clicking sound is heard when the unit is shaken.</b></p>	<ul style="list-style-type: none"> <li>● This is the sound of the lens moving and is not a defect. This sound will no longer be heard when the unit is turned on and set this unit to the Motion Picture Recording Mode or Still Picture Recording Mode.</li> </ul>
<p><b>Object seems to be warped.</b></p>	<ul style="list-style-type: none"> <li>● Object seems to be warped slightly when the object moves across the image very fast, but this is because the unit is using MOS for the image sensor. This is not a malfunction.</li> </ul>
<p><b>The lens or LCD monitor fog up.</b></p>	<ul style="list-style-type: none"> <li>● This is due to condensation. It is not a malfunction. Please refer to page 6.</li> </ul>

Power	
Problem	Check points
<p><b>This unit cannot be turned on.</b></p> <p><b>This unit does not stay on long enough.</b></p> <p><b>Battery runs down quickly.</b></p>	<ul style="list-style-type: none"> <li>● Charge the battery again to ensure it is sufficiently charged. (→ 12)</li> <li>● In cold places, the battery using time becomes shorter.</li> <li>● The battery has a limited life. If the operating time is still too short even after the battery is fully charged, the battery has worn out and needs to be replaced.</li> </ul>
<p><b>This unit cannot be operated though it is turned on.</b></p> <p><b>This unit does not operate normally.</b></p>	<ul style="list-style-type: none"> <li>● Remove the battery or AC adaptor, wait about 1 minute and then reconnect the battery or AC adaptor. Then about 1 minute later, turn on the unit again. (Conducting the above operation while the media is being accessed may damage the data on the media.)</li> <li>● If normal operation is still not restored, detach the power connected, and consult the dealer who you purchased this unit from.</li> </ul>
<p><b>“ERROR OCCURRED. PLEASE TURN UNIT OFF, THEN TURN ON AGAIN.” is displayed.</b></p>	<ul style="list-style-type: none"> <li>● The unit has automatically detected an error. Restart the unit by turning the unit off and on.</li> <li>● The unit will be turned off in about 1 minute if the unit is not turned off and on.</li> <li>● Repair is needed if it is repeatedly displayed even if it is restarted. Detach the power connected, and consult the dealer who you purchased this unit from. Do not attempt to repair the unit by yourself.</li> </ul>

## Recording

Problem	Check points
<p><b>Colour or brightness of the image changes, or you may see horizontal bars in the image.</b></p> <p><b>The LCD monitor flickers indoors.</b></p>	<ul style="list-style-type: none"> <li>● Colour or brightness of the image may change, or you may see horizontal bars in the image when the object is recorded under fluorescent light, mercury light or sodium light, etc., but this is not a malfunction.</li> <li>● In Motion Picture Recording Mode, record in Intelligent Auto Mode/Intelligent Auto Plus Mode or set the shutter speed as follows:             <ul style="list-style-type: none"> <li>– When [REC FORMAT] is set to [24p]: Set to 1/50 seconds in areas where the power supply frequency is 50 Hz, or 1/60 seconds in areas where the frequency is 60 Hz.</li> <li>– When [REC FORMAT] is set to a setting other than [24p]: Set to 1/100 seconds in areas where the power supply frequency is 50 Hz, or 1/125 seconds in areas where the frequency is 60 Hz.</li> </ul> </li> <li>● In Still Picture Recording Mode, this will not affect the recorded image.</li> <li>● In the following cases, setting the shutter speed to 1/100 seconds reduces the intensity of the problem:             <ul style="list-style-type: none"> <li>– In FULL HD Slow Motion Mode</li> <li>– (For the <span style="border: 1px solid black; padding: 0 2px;">VX3</span>) Slow &amp; Quick Video Mode</li> </ul> </li> </ul>

## Playback

Problem	Check points
<p><b>Scenes/still pictures cannot be played back.</b></p>	<ul style="list-style-type: none"> <li>● Any scenes/still pictures where the thumbnails are displayed as <span style="border: 1px solid black; padding: 0 2px;">!</span> cannot be played back.</li> </ul>

Please refer to "Operating Instructions (PDF format)" for details.

# Specifications

## 4K Video Camera/High Definition Video Camera

Information for your safety

### Power source:

5.0 V --- (When using AC adaptor)

3.6 V --- (When using battery)

### Power consumption:

VX3

Recording; 5.4 W

Charging; 7.7 W

V900

Recording; 4.5 W

Charging; 7.7 W

\*1 When [REC FORMAT] is set to [4K MP4] or [24p]

\*2 When [REC FORMAT] is set to [AVCHD] or [MP4]

\*3 When [REC FORMAT] is set to [24p]

\*4 When [REC FORMAT] is set to [4K MP4], or when [REC FORMAT] is set to [24p] with [REC MODE] set to [2160/24p]





	HC-VX3	HC-V900
<b>Motion picture recording format</b>	[4K MP4], [MP4], [24p]: MPEG-4 AVC file format compliant (.MP4) [AVCHD]: AVCHD format version 2.0 compliant (AVCHD Progressive)	[MP4], [24p]: MPEG-4 AVC file format compliant (.MP4) [AVCHD]: AVCHD format version 2.0 compliant (AVCHD Progressive)
<b>Motion picture compression</b>	MPEG-4 AVC/H.264	
<b>Audio compression</b>	[4K MP4], [MP4], [24p]: AAC/2 ch [AVCHD]: Dolby Audio™/5.1 ch (built-in microphone), 2 ch (built-in microphone/ external microphone)	[MP4], [24p]: AAC/2 ch [AVCHD]: Dolby Audio™/5.1 ch (built-in microphone), 2 ch (built-in microphone/ external microphone)

	HC-VX3	HC-V900
<b>Recording mode and transfer rate</b>	<p><b>[4K MP4]</b> [2160]: Maximum 72 Mbps (VBR)</p> <p><b>[MP4]</b> [1080/50M]: Maximum 50 Mbps (VBR) [1080/28M]: Maximum 28 Mbps (VBR) [720]: Average 9 Mbps (VBR)</p> <p><b>[AVCHD]</b> [1080/50p]: Maximum 28 Mbps (VBR) [PH]: Maximum 24 Mbps (VBR) [HA]: Average 17 Mbps (VBR) [HG]: Average 13 Mbps (VBR) [HE]: Average 5 Mbps (VBR)</p> <p><b>[24p]</b> [2160/24p]: Maximum 72 Mbps (VBR) [1080/24p]: Maximum 50 Mbps (VBR)</p> <ul style="list-style-type: none"> <li>Refer to the operating instructions (PDF format) for the picture size and recordable time of a motion picture.</li> </ul>	<p><b>[MP4]</b> [1080/50M]: Maximum 50 Mbps (VBR) [1080/28M]: Maximum 28 Mbps (VBR) [720]: Average 9 Mbps (VBR)</p> <p><b>[AVCHD]</b> [1080/50p]: Maximum 28 Mbps (VBR) [PH]: Maximum 24 Mbps (VBR) [HA]: Average 17 Mbps (VBR) [HG]: Average 13 Mbps (VBR) [HE]: Average 5 Mbps (VBR)</p> <p><b>[24p]</b> [1080/24p]: Maximum 50 Mbps (VBR)</p>
<b>Still picture recording format</b>	<p>JPEG (Design rule for Camera File system, based on Exif 2.2 standard)</p> <ul style="list-style-type: none"> <li>Refer to the operating instructions (PDF format) for picture size of a still picture and number of recordable pictures.</li> </ul>	
<b>Recording media</b>	<p>SD Memory Card SDHC Memory Card SDXC Memory Card</p> <ul style="list-style-type: none"> <li>Refer to page 15 for details on SD cards usable in this unit.</li> </ul>	
<b>Image sensor</b>	<p>1/2.5 type (1/2.5") 1MOS image sensor Total: 8570 K Effective pixels: Motion picture; 8290 K (16:9)*<sup>1</sup>, 6170 K (16:9)*<sup>2</sup> Still picture; 8290 K (16:9), 6220 K (4:3)</p>	<p>1/2.5 type (1/2.5") 1MOS image sensor Total: 8570 K Effective pixels: Motion picture; 6170 K (16:9) Still picture; 8290 K (16:9), 6220 K (4:3)</p>

	HC-VX3	HC-V900
<b>Lens</b>	Auto Iris, 24× optical zoom, F1.8 to F4.0 Focal length: 4.12 mm to 98.9 mm (Full range AF) 35 mm equivalent: Motion picture; 25 mm to 600 mm (16:9) <sup>*1</sup> , 28.9 mm to 693.7 mm (16:9) <sup>*2</sup> Still picture; 25 mm to 600 mm (16:9), 30.6 mm to 734.4 mm (4:3) Minimum focus distance: Normal; Approx. 10 cm (Wide)/ Approx. 1.2 m (Tele) Intelligent Auto Macro; Approx. 5 cm (Wide)	Auto Iris, 24× optical zoom, F1.8 to F4.0 Focal length: 4.12 mm to 98.9 mm (Full range AF) 35 mm equivalent: Motion picture; 25 mm to 600 mm (16:9) <sup>*3</sup> , 28.9 mm to 693.7 mm (16:9) <sup>*2</sup> Still picture; 25 mm to 600 mm (16:9), 30.6 mm to 734.4 mm (4:3) Minimum focus distance: Normal; Approx. 10 cm (Wide)/ Approx. 1.2 m (Tele) Intelligent Auto Macro; Approx. 5 cm (Wide)
<b>Filter diameter</b>	62 mm	
<b>Zoom</b>	24× optical zoom, 32× <sup>*4</sup> /48× <sup>*2</sup> i.Zoom, 70×/1500× digital zoom	24× optical zoom, 48× i.Zoom, 70×/1500× digital zoom
<b>Image stabilizer function</b>	Optical (Hybrid Optical Image Stabilizer, Optical Image Stabilizer Lock function)	
<b>Creative Control</b>	[Miniature Effect]/[Silent movie]/[8mm movie]/[Time Lapse Rec]	
<b>HDR movie</b>	Low/High	
<b>Monitor</b>	Capacitive touch screen 7.6 cm (3.0") LCD monitor, Approx. 1840 K dots Image display area (16:9): Approx. 1550 K dots	
<b>Microphone</b>	5.1 channel surround microphone/Zoom microphone/Focus microphone/ Stereo microphone	
<b>Minimum required illumination</b>	Approx. 1.5 lx (1/25 with Low Light Mode in the Scene Mode) Approx. 0.5 lx with the Night Mode ([COLOUR]) function	
<b>HDMI micro connector video output level</b>	HDMI™ 2160p/1080p/1080i/576p	HDMI™ 1080p/1080i/576p
<b>Headphone output</b>	3.5 mm diameter stereo mini jack, output level: 85 mV (load impedance 32 Ω)	
<b>HDMI micro connector audio output level</b>	[4K MP4], [MP4], [24p]: Linear PCM [AVCHD]: Dolby Audio/Linear PCM	[MP4], [24p]: Linear PCM [AVCHD]: Dolby Audio/Linear PCM
<b>MIC input</b>	3.5 mm diameter stereo mini jack, plug-in power compatible, Input level: -60 dBV (microphone sensitivity -40 dB equivalent: 0 dB = 1 V/Pa 1 kHz), Input impedance: 3900 Ω	
<b>LINE input</b>	3.5 mm diameter stereo mini jack, Input level: -10 dBV	—

	HC-VX3	HC-V900
<b>REMOTE terminal</b>	2.5 mm diameter super mini jack × 1 Remote control terminal of serial communication	
<b>USB</b>	USB Type-C terminal, Hi-Speed USB (USB 2.0) Card reader function (Read only, No copyright protection support) Supports USB power supply and USB charging (when main unit is turned off)	
<b>Dimensions</b>	68 mm (W)×77 mm (H)×141 mm (D) (including projecting parts)	
<b>Mass</b>	Approx. 431 g [without lens hood, battery (supplied) and an SD card (optional)]	
<b>Mass in operation</b>	With lens hood, battery (supplied) and an SD card (optional): Approx. 482 g	
<b>Operating temperature</b>	0 °C to 40 °C	
<b>Operating humidity</b>	10%RH to 80%RH	
<b>Battery operation time</b>	See page 14	

The symbols on this product (including the accessories) represent the following:

	AC
	DC
	Class II equipment (The construction of the product is double-insulated.)
	ON
	Standby

# About copyright

## ■ Carefully observe copyright laws

Recording of pre-recorded tapes or discs or other published or broadcast material for purposes other than your own private use may infringe copyright laws. Even for the purpose of private use, recording of certain material may be restricted.

## ■ Licenses



- SDXC Logo is a trademark of SD-3C, LLC.
- "AVCHD", "AVCHD Progressive" and the "AVCHD Progressive" logo are trademarks of Panasonic Holdings Corporation and Sony Corporation.
- Manufactured under license from Dolby Laboratories.  
Dolby, Dolby Audio, and the double-D symbol are trademarks of Dolby Laboratories Licensing Corporation.
- The terms HDMI, HDMI High-Definition Multimedia Interface, HDMI Trade dress and the HDMI Logos are trademarks or registered trademarks of HDMI Licensing Administrator, Inc.
- USB Type-C® and USB-C® are registered trademarks of USB Implementers Forum.
- QR Code is a registered trademark of DENSO WAVE INCORPORATED.
- Other names of systems and products mentioned in these instructions are usually the registered trademarks or trademarks of the manufacturers who developed the system or product concerned.

This product is licensed under the AVC Patent Portfolio License for the personal use of a consumer or other uses in which it does not receive remuneration to (i) encode video in compliance with the AVC Standard ("AVC Video") and/or (ii) decode AVC Video that was encoded by a consumer engaged in a personal activity and/or was obtained from a video provider licensed to provide AVC Video. No license is granted or shall be implied for any other use. Additional information may be obtained from MPEG LA, L.L.C.

See <http://www.mpegla.com>

This product incorporates the following software:

- (1) the software developed independently by or for Panasonic,
- (2) the software owned by third party and licensed to Panasonic,
- (3) the software licensed under the GNU General Public License, Version 2.0 (GPL V2.0),
- (4) the software licensed under the GNU LESSER General Public License, Version 2.1 (LGPL V2.1), and/or
- (5) open source software other than the software licensed under the GPL V2.0 and/or LGPL V2.1.

The software categorized as (3) - (5) are distributed in the hope that it will be useful, but WITHOUT ANY WARRANTY, without even the implied warranty of MERCHANTABILITY or FITNESS FOR A PARTICULAR PURPOSE. Refer to the detailed terms and conditions thereof, which can be displayed by following the procedure described in [SOFTWARE INFO] under "Using the Setup Menu" in the Operating Instructions (PDF format).

At least three (3) years from delivery of this product, Panasonic will give to any third party who contacts us at the contact information provided below, for a charge no more than our cost of physically performing source code distribution, a complete machine-readable copy of the corresponding source code covered under GPL V2.0 or LGPL V2.1, as well as the respective copyright notice thereof.

Contact Information: [oss-cd-request@gg.jp.panasonic.com](mailto:oss-cd-request@gg.jp.panasonic.com)

The source code and the copyright notice are also available for free in our website below.  
<https://docs.connect.panasonic.com/oss/>

Manufactured by:

Panasonic Entertainment & Communication Co., Ltd.

1-10-12, Yagumo-higashi-machi, Moriguchi City, Osaka, Japan

Importer for UK:

Panasonic UK, a branch of Panasonic Marketing Europe GmbH

Maxis 2, Western Road, Bracknell, Berkshire, RG12 1RT

Importer for EU:

Panasonic Marketing Europe GmbH

Hagenauer Strasse 43, 65203 Wiesbaden, Germany

Authorized Representative in EU:

Panasonic Marketing Europe GmbH

Panasonic Testing Centre

Winsbergring 15, 22525 Hamburg, Germany



EU



---

**Panasonic Entertainment & Communication Co., Ltd.**

Web site: <http://www.panasonic.com>

© Panasonic Entertainment & Communication Co., Ltd. 2024

DVQX2556ZA